

Precision Balances

FZ-i FX-i

Series



FZ-i



FX-i



AND ...Clearly a Better Value
A&D Company, Limited
<http://www.aandd.jp>

“High Functionality You Can Afford”

The FZ-i/FX-i Series, a new addition to A&D’s precision balances, rivals our GX/GF Series in performance and quality, but offers higher accessibility, bringing to you a cost-effective solution for a diverse array of applications.

Newly developed, Air-pump Controlled Internal Calibration* (FZ-i models only) *Patent Pending

For the internal calibration of the FZ-i Series, A&D adopted a direct-driving method that utilizes air pressure for its power source. This new method features a simple structure, high reliability and a fail-safe mechanism – the internal mass returns to the original position even if the calibration is interrupted by power failure, etc.

One Touch Automatic Calibration (FZ-i models only)

With just one press of a key, you can ensure the accuracy of your balance.

Compact, B5 Size Footprint

By taking advantage of our Compact Super Hybrid Sensor (C-SHS) technology*, A&D has significantly reduced the size of the FZ-i/FX-i Series – 25% smaller footprint than the GX/GF Series, making it ideal for installation and use in narrow spaces. *Patent Pending

Fast, 1 Second Stabilization

The C-SHS combines the best of magnetic force restoration and single point parallelogram load sensing technologies. This allows the C-SHS to realize a response speed of **just 1 second** while maintaining extremely high span stability. The FZ-i/FX-i Series will maximize your productivity and efficiency.

Shock Absorber Function* *Patent Pending

The internal shock absorber protects the C-SHS from the adverse effects of vertical and transverse overloading.



LAN-Ethernet Interface (FXi-08) with WinCT-Plus Software

WinCT-Plus software makes it possible for the user to easily set up an IP address, subnet mask, etc. The user can also send commands for control and acquisition of data from multiple balances.

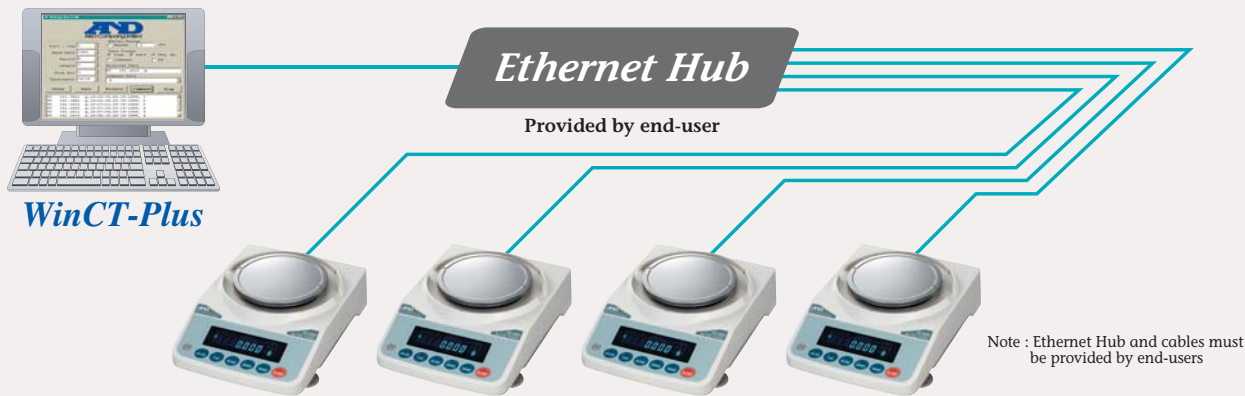

Quick USB Interface (FXi-02)

Easy-to-use optional USB interface, **with no driver installation necessary**, for transfer of weighing data to a computer (applicable OS – Windows 98 OSR2 or later)

Standard RS-232C Interface

Incorporates bi-directional communication with a PC, printer or other peripheral devices.

Multiple Weighing Units

Programmable or standard weighing units of measurement can be selected; g, pcs, %, oz, lb, L oz, ozt, ct, mom, dwt, GN, tl, tol, mes and MLT

GLP/GMP/GCP/ISO Compliant

In accordance with GLP and LIMS regulations, the balance ID number and calibration data can be printed out using A&D's AD-8121B or a PC

Statistical Calculation Function

Can display and/or output statistical calculation data as No. (number of data), SUM (total), MAX (maximum), MIN (minimum), R [range (maximum – minimum)], AVE (average), SD (standard deviation) and CV (coefficient of variation)

Response Indicator Function

Selectable FAST, MID or SLOW response to suit weighing environment conditions.

ACAI – Automatic Counting Accuracy Improvement

This counting function recalculates the average unit weight each time a sample is added to eliminate errors caused by variations in unit weight

Built-in Rechargeable Battery (FXi-09)

An optional Ni-MH rechargeable battery pack can be fitted into the FZ-i/FX-i Series for use without AC power and for mobile applications (10 hours charging time for 8 hours operation)



Large Breeze Break (FXi-11)

The small breeze break comes as standard with all the FZ-i models, FX-120i, FX-200i and FX-300i.

Specifications

	FZ-120i FX-120i	FZ-200i FX-200i	FZ-300i FX-300i	FZ-1200i FX-1200i	FZ-2000i FX-2000i	FZ-3000i FX-3000i
Weighing capacity	122g	220g	320g	1220g	2200g	3200g
Minimum weighing value	0.001g			0.01g		
Counting mode	Minimum unit mass	0.001g			0.01g	
	Number of samples	5, 10, 25, 50 or 100 pieces				
Percent mode	Minimum 100% reference mass	0.100g			1.00g	
	Minimum 100% display	0.01%, 0.1%, 1% (depends on the reference mass stored)				
Repeatability (Standard Deviation)	0.001g			0.01g		
Linearity	±0.002g			±0.02g		
Stabilization time (typically set at FAST)	Approx. 1 second					
Sensitivity drift (10°C to 30°C)	±2ppm / °C					
Operating temperature	5°C to 40°C (41°F to 104°F), 85%RH or less (no condensation)					
Display type	Vacuum Fluorescent Display (VFD)					
Display refresh rate	5 times /second, 10 times /second or 20 times /second					
Standard serial interface	RS-232C Interface					
Weighing pan (diameter)	130mm			150mm		
External calibration mass	100g 50g	200g 100g	300g 200g 100g	1000g 500g	2000g 1000g	3000g 2000g 1000g
AC adaptor	Confirm that the adaptor type is correct for the local voltage and power receptacle					
Power consumption	Approx. 11VA (supplied to the AC adaptor)					
External dimensions	193 (W) X 262.5 (D) X 85.5 (H) mm					
Net weight	FZ-i Approx. 3.0kg / FX-i Approx. 2.5kg					

Options

- FXi-02*** Quick USB interface with cable
- FXi-08*** Ethernet interface with WinCT-Plus software
- FXi-09*** Built-in rechargeable battery
- FXi-10** Small breeze break
- FXi-11** Large breeze break
- FXi-12** Animal weighing pan (FZ,FX-1200i / 2000i / 3000i)
- FXi-15** Carrying case

* FXi-02, FXi-08 and FXi-09 cannot be used at the same time.

External Dimensions (mm/inches)

Pan size

Model	A
FZ,FX-120i / 200i / 300i	130 / 5.12
FZ,FX-1200i / 2000i / 3000i	150 / 5.91

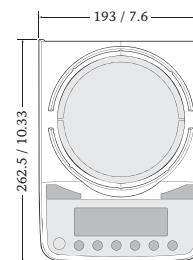
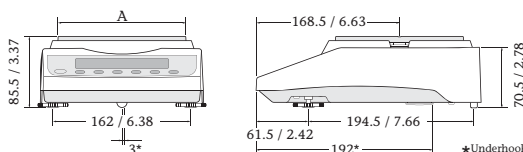

Accessories

- AD-1683** Static eliminator
- AD-1684** Electrostatic fieldmeter
- AD-1689** Tweezers for calibration weight
- AD-8920A** Remote display
- AD-8922** Remote controller
- AD-8121B** Compact printer
- AD-8118C** Universal printer
- AX-KO2466-200** RS-232C cable (9P-9P)
- AD-8526** Serial/Ethernet converter
- AX-USB-9P** Serial/USB converter
- AX-CARATPAN-W** Carat pan (silver, 2pcs)
- AX-CARATPAN-B** Carat pan (black, 2pcs)
- AX-FXi-31** Main unit cover (5pcs)

Dimensions with Small Breeze Break (FXi-10)

(Comes equipped with FZ,FX-120i/200i/300i, FZ-1200i/2000i/3000i)

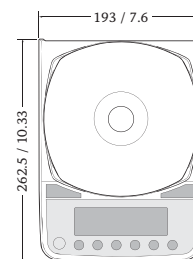
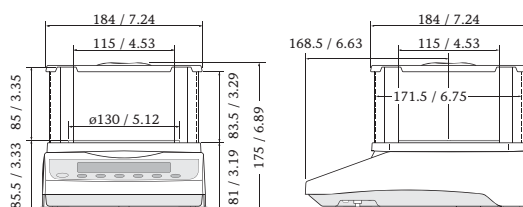

Dimensions with Large Breeze Break (FXi-11)

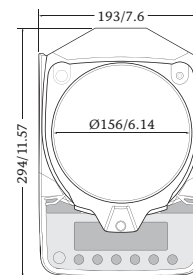
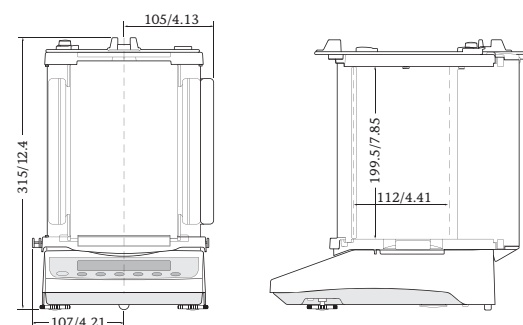

AD-8121B

A&D

...Clearly a Better Value

A&D Company, Limited

3-23-14 Higashi-Ikebukuro, Toshima-ku, Tokyo 170-0013 JAPAN
Telephone:[81](3) 5391-6132 Fax:[81](3) 5391-6148
http://www.aandd.jp

A&D ENGINEERING, INC.

1756 Automation Parkway, San Jose, CA 95131 U.S.A.
Telephone:[1](408) 263-5333 Fax:[1](408) 263-0119

A&D MERCURY PTY. LTD.

32 Dew Street, Thebarton, South Australia 5031 AUSTRALIA
Telephone:[61](8) 8301-8100 Fax:[61](8) 8352-7409

A&D INSTRUMENTS LTD.

Unit 24/26 Blacklands Way Abingdon Business Park,
Abingdon, Oxon OX14 1DY UNITED KINGDOM
Telephone:[44](1235) 550420 Fax:[44](1235) 550485

<German Sales Office>

Große Straße 13 b 22926 Ahrensburg GERMANY
Telephone:[49](0) 4102 459230 Fax:[49](0) 4102 459231

A&D KOREA Limited

Manhattan Bldg. 8F, 36-2 Yoido-dong, Youngdeungpo-gu, Seoul, KOREA
Telephone:[82](2) 780-4101 Fax:[82](2) 782-4280

A&D RUS CO., LTD.

Vereyskaya str. 112 Kuntsevo Block, 121357,
Moscow, RUSSIA
Telephone: [7] (495) 937-33-44 Fax: [7] (495) 937-55-66

A&D Instruments India Private Limited

509 Udyog Vihar Phase V
Gurgaon-122 016, Haryana, INDIA
Telephone: [91](124) 471-5555 Fax: [91](124) 471-5599